

2022/2023

# solutions

gear manufacturing technology magazine

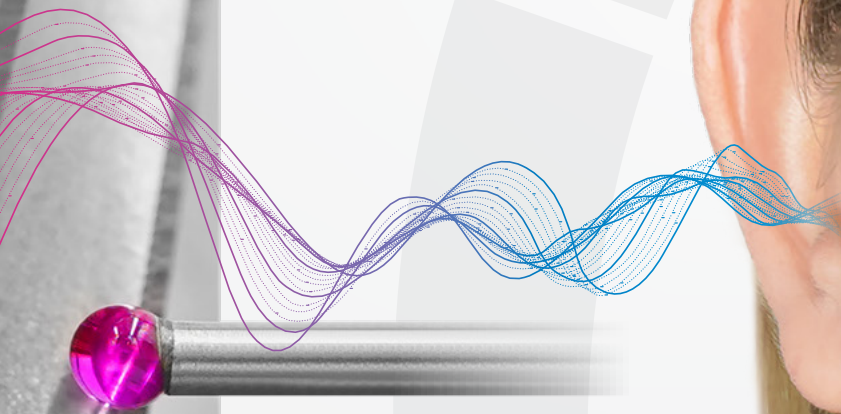

## Game Changer

In-process inspection and nano technology revolutionize gear manufacturing

## Large Gears

State-of-the-art large gear manufacturing

## Mute Transmission Noise

KISSsoft meets RecurDyn to create a seamless approach to e-drive transmission and gearbox design



John J. Perrotti

Chairman and  
Chief Executive Officer

Dear Valued Customers:

While the global economic outlook remains uncertain there are common themes that are quite clear and consistent across virtually all manufacturing industries. Most notable are inflationary pressures, supply chain disruptions and labor shortages. While there are multiple means to address these challenges the one that likely rises to the top as the most effective is investment in new manufacturing technology. Productivity, versatility and quality advantages are more compelling than ever before.

Gleason remains one of the largest global providers of advanced manufacturing solutions and the largest global provider of gear technology solutions. Our array of products ranges from design to manufacture to inspection. We believe by having expertise across the entire value chain and seamlessly connecting these elements provides our customers a significant competitive advantage. This formula translates well no matter what the industry or application. Our technologies are used across many industries, complemented by targeted products based upon our deep understanding of specific customers' requirements.

Beyond our product portfolio, the one other factor that remains vital, particularly in these volatile times, is being a reliable and trustworthy partner. Gleason, founded 157 years ago, has prided itself on taking a long-term view in how it deals with its partners, including its customers. While we too are impacted by the external factors that influence today's economy our commitment to our customers and our passion for serving them have never been greater.

We are pleased that travel in most of the world has reopened and that we are once again regularly exhibiting at trade shows. At our trade shows, we are live-streaming from several of our factories to provide those in attendance at the shows and those unable to attend the shows a broader first-hand view to many of our latest products and technologies. I also encourage you to join our Gear Trainer Webinar series, where we have had thousands of participants to date from more than thirty countries. This series has become a leading forum for gear education covering a broad range of topics spanning gear design, manufacturing, and measurement.

We deeply value the loyalty of our customers and thank you for your confidence and support over many years. We look forward to being an important partner for you as you continue to transform your business to fully realize market opportunities.

Yours sincerely,

- 04 Cover Story: The Game Changer for e-Drive Gear Manufacture**
- 08 Inspection at Nano Level**
- 10 Chamfer Cutting – Stand-Alone or Fully Integrated**
- 14 ODG – The 'Go Anywhere' Gear Company**
- 18 NGC – The Powerhouse for Windpower Transmissions**
- 22 CMD – A Giant('s) Success Story**
- 26 The Master Class in Profile Grinding of Large Gears**
- 28 Significant Savings for Face Milling of Bevel and Hypoid Gears**
- 30 Fast and Agile Production of Truck-Size Bevel Gears**
- 34 Digital Service for Transformers**
- 38 KISSsoft and RecurDyn Mute Transmission Noise**



# The Gamer Changer for e-Drive Gear Manufacture: In-Process Gear Inspection and Noise Analysis

E-drive gears differentiate from other gears in two essential points: higher quality and the need for an excellent noise behavior. A new technology caters perfectly to this demand while changing the existing manufacturing process chain.

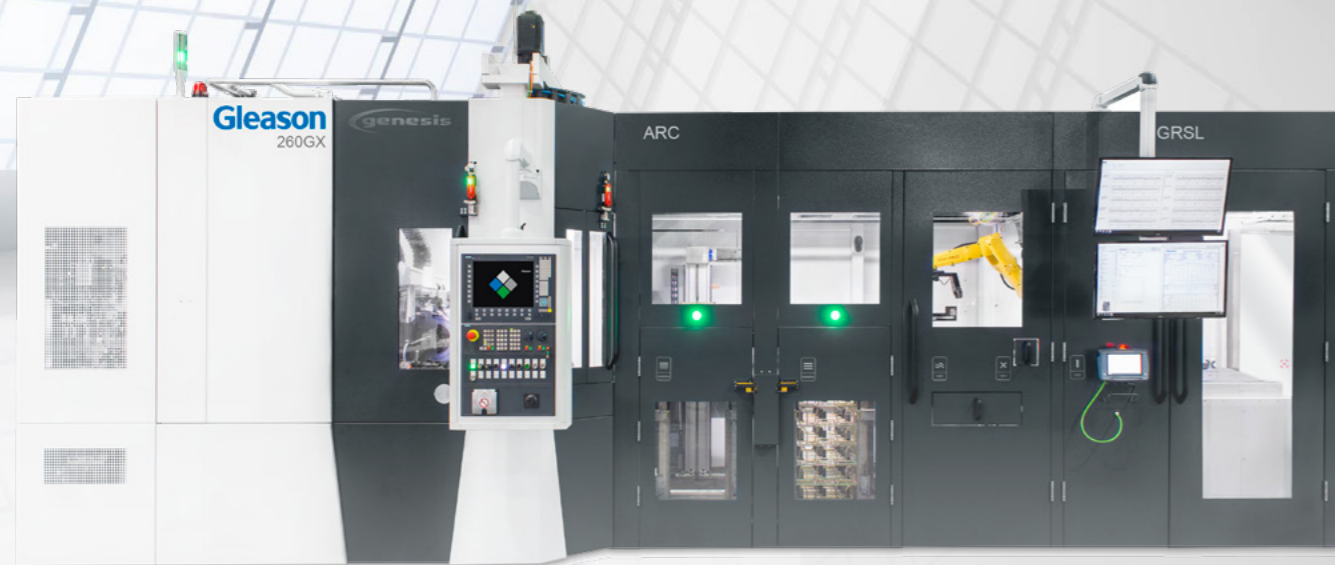

Hard Finishing Cell (HFC) fully automated manufacturing cell features a highly productive Genesis® GX Series Threaded Wheel Grinding Machine, a washing and part marking station and a GRSL metrology system, all connected by an integrated robot loader with a basket-based palletizer system. The gantry robot services the complete workflow within the cell, including part handling and feeding machine, washing and part marking stations, as well as the inspection unit. The stacking cell accommodates baskets of various manufacturers and styles and is ideally suited for the autonomous processing of large lot sizes of gears.

In conventional gear manufacturing, quality control is carried out randomly, with only a few parts actually inspected. This is mainly due to the significantly longer measuring times in comparison to the actual production time, and limited overall measuring capacity to cope with increased inspection demands. In order to guarantee process reliability, statistics are instead used to validate the process, resulting in a significant reduction of the manufacturing tolerance in comparison to the drawing tolerance.

In addition, constantly increasing power density requirements and the growing importance of excellent noise behavior of transmissions, especially in new e-drive concepts, have resulted in very tight tolerances. Relying on statistical evaluation makes the production of such gears more challenging and expensive.

A new inspection concept developed by Gleason, called GRSL (Gear Rolling System with Integrated Laser Scanning) features a combination of double flank roll testing and laser scanning. With this

completely new approach, inspection time is significantly reduced and gets close to the time required for the hard finishing operation. As a result, up to 100% in-process inspection of all teeth has become a reality, eliminating the need for statistical process evaluation.



Watch the HFC in action



Genesis 260GX Threaded Wheel Grinding Machine.



70ARC Automation System: Modular cart bay with robotic loading.

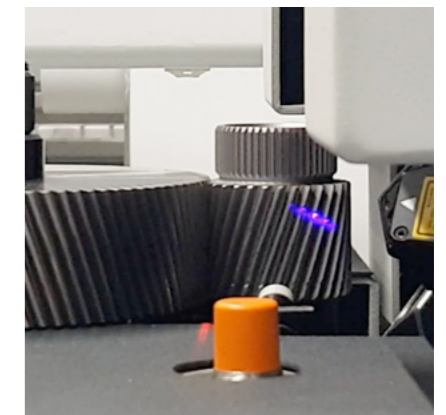

GRSL Gear Rolling System with Integrated Laser Scanning.



Laser scanning provides comprehensive data volumes beyond standard gear characteristics such as profile, lead, pitch, runout and size. Understanding the profile and lead of all teeth makes it possible to conduct an “Advanced Waviness Analysis” resulting in an order analysis of the gear topography including the corresponding amplitudes. Now, potential noise issues like “ghost orders” can be detected, which are not related to the mesh harmonics of the gear and are typically caused by small irregularities created during the manufacturing process or involved production machinery. Ghost orders can cause problems once they exceed specific amplitudes.

With the advanced waviness analysis and the possibility to inspect up to 100% of gears it is possible to sort out critical parts before they are assembled within the gear box.

This revolutionary new inspection concept is available as a stand-alone machine with autonomous automation or adapted for simple integration into existing production lines. It's also integral to Gleason's new HFC (Hard Finishing Cell), which combines the latest Genesis 200GX Threaded Wheel Grinding Machine, fast, flexible automation system and GRSL inspection into a fully automated Closed Loop manufacturing system to

keep gear production within strictest tolerances – at all times. Compared to the conventional measuring process, in-process inspection and Closed Loop correction ensure optimum quality in a fraction of the time. With up to 100% quality control, statistical evaluation can be eliminated from the manufacturing process, resulting in stringent compliance with requested tolerances according to original drawings.



GRSL combines multiple inspection methods in one platform: Optical inspection of profile, lead and pitch, DOP and tooth thickness, double flank composite testing, sophisticated in-process gear noise analysis.

During the roll testing cycle, laser heads move automatically into position to scan both gear flanks (left and right) simultaneously. In addition, different sections along the face width of the gear can be scanned to inspect all required gear characteristics including lead. With laser technology, the overall inspection time is significantly reduced.

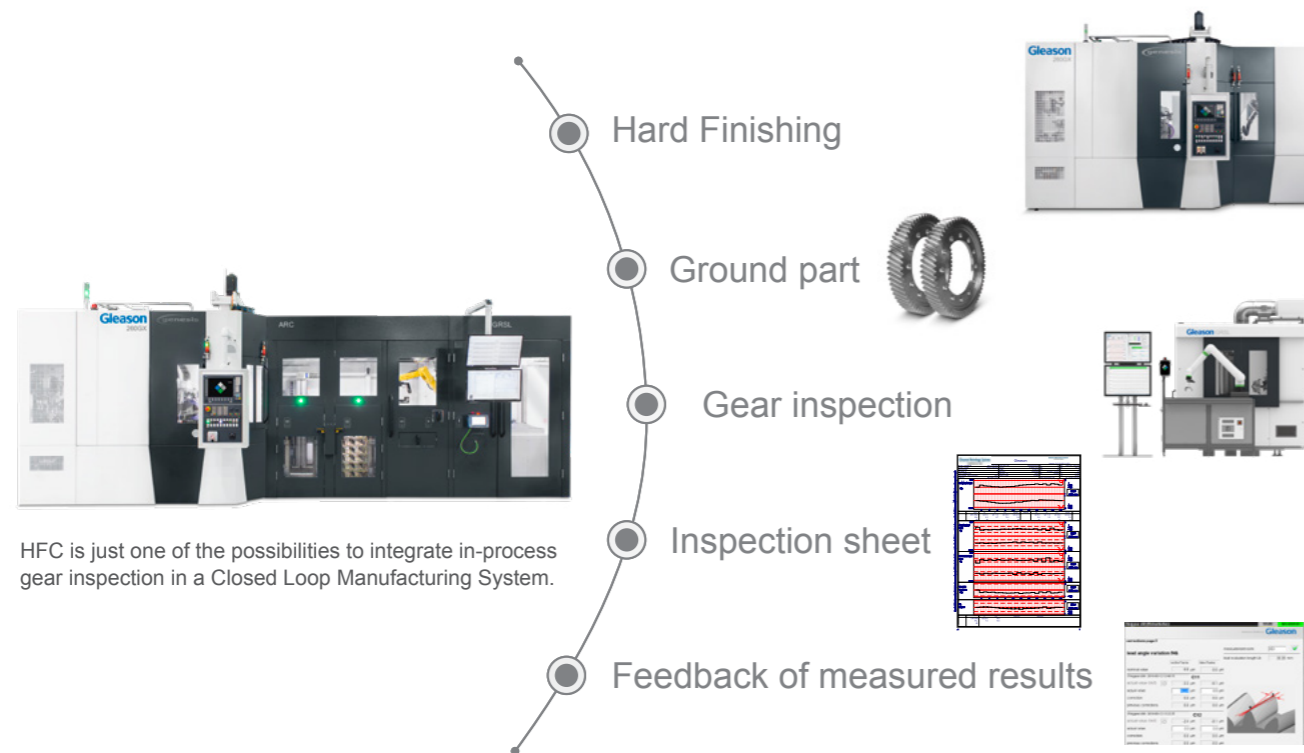

HFC is just one of the possibilities to integrate in-process gear inspection in a Closed Loop Manufacturing System.

Gleason's Closed Loop system connects hard finishing by grinding or honing with advanced metrology systems. Inspection results are directly returned from the metrology center to the hard finishing machine without any involvement of the operator. The machine compares the measured values with the target nominal values and automatically makes the required corrections.

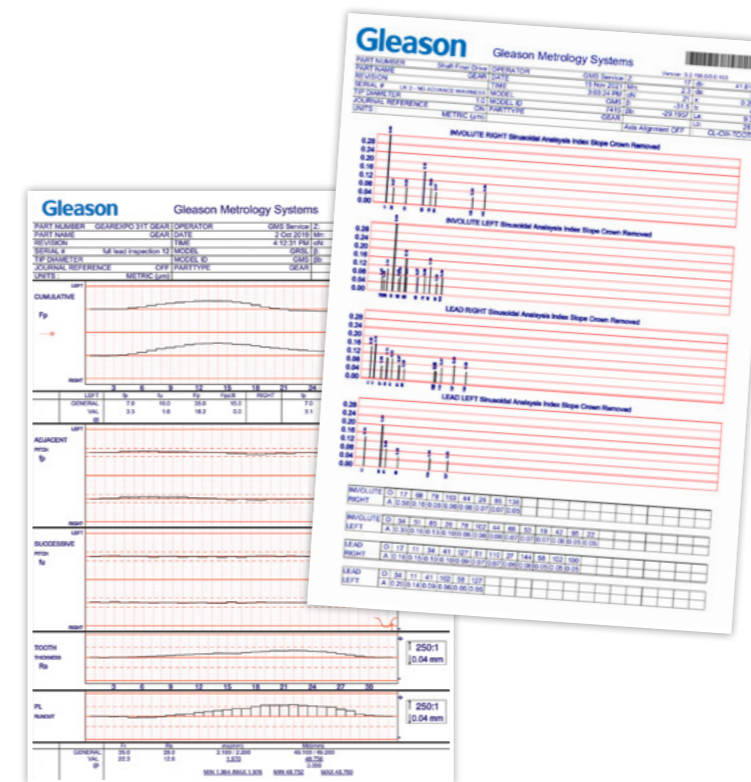

GRSL charts including advanced waviness analysis.

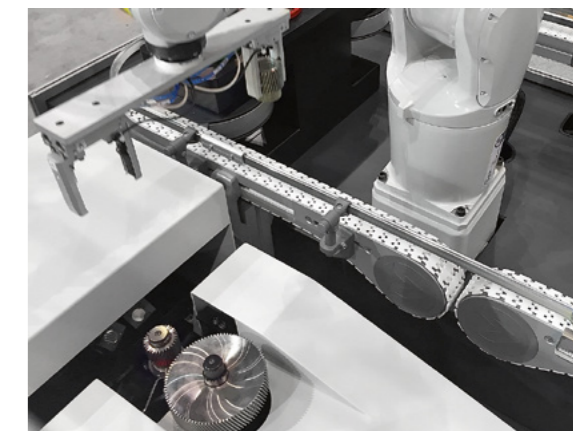

GRSL can be provided as a stand-alone system, connecting to various automation systems, or as a fully integrated manufacturing cell.



**Dr. Antoine Türich**  
Director of Product Management  
Hard Finishing Solutions

Gleason Corporation



nano.

# Inspection at Nano Level

The new Series of GMS Analytical Gear Inspection Systems makes all the difference in meeting next level gear noise detection demands.

The new 300GMS® Gear Metrology System inspects gears at sub-micron level, performs advanced waviness analysis and evaluates gear noise using state-of-the-art analysis tools. 300GMS nano is ideally suited to support the production of automotive EV transmission gears with the requirement of minimal gear noise.

The 300GMS nano Gear Metrology System covers the entire range of gear inspection requirements, including the measuring of fine pitch gears. Users can measure sub-micron surface finishes with a skidless probe, analyze waviness for profile and lead, measure pitch, and perform noise analysis with the Advanced Waviness Analysis software tool. The 300GMS nano Gear Metrology System is

equipped with a high-precision SP25 3D scanning probe head, a wide range of styli, and a proprietary probe calibration library that supports roughness evaluations to DIN, ISO, ANSI and other standards. It also offers 3D measurement and analysis features that are normally offered by a CMM.

In addition to involute and non-involute gears and other rotational symmetric parts, the 300GMS nano Gear Metrology System inspects a wide range of gear cutting tools, including hobs, Power Skiving tools and shaper cutters, shaving cutters, stick blades for bevel gear cutter heads and even cutters for rack manufacturing. The 300GMS nano is equipped with the patented Advanced Operator Pendant (AOP)

enabling operators to record video and voice messages and to monitor environmental conditions. It may also be used to support remote maintenance via video telephony and can read bar and QR code information directly into the machine, for further use in inspection protocols or to select the appropriate inspection cycle.

300GMS nano uses the latest GAMA™ 3.2 application and control software, which is fully compatible with Windows and can be easily integrated into server environments. GAMA also provides an interface to SPC data evaluation and Gleason Connect® remote maintenance services, among others. Gleason's "Smart Loop" allows the 300GMS nano to send gear inspection results for automatic



correction of machine settings directly to Gleason production machines, such as Power Skiving, gear grinding and honing machines. Additionally, inspection results can be forwarded to KISSsoft® Design Software to optimize gear designs.

The 300GMS nano is also available as a "P" version for installation within the manufacturing environment. Excellent vibration damping makes the 300GMSP nano suitable for the harshest manufacturing environments and placement in close proximity to the assigned production machines. Integrated functions for temperature compensation of the workpiece and the measuring system, as well as insensitivity to environmental contaminants such as oil mist and dust, complement the 300GMSP nano's shop floor suitability.



See the new 300GMS nano in action

**Klaus Deininger**  
International Sales Manager  
Gleason Metrology Systems



# Chamfer Cutting: Stand-Alone or Fully Integrated

Gleason's new stand-alone Genesis® 280CD Gear Chamfering Machine takes cylindrical gear chamfering to a new level, offering both Chamfer Hobbing for high volumes and Fly Cutter Chamfering for maximum flexibility.

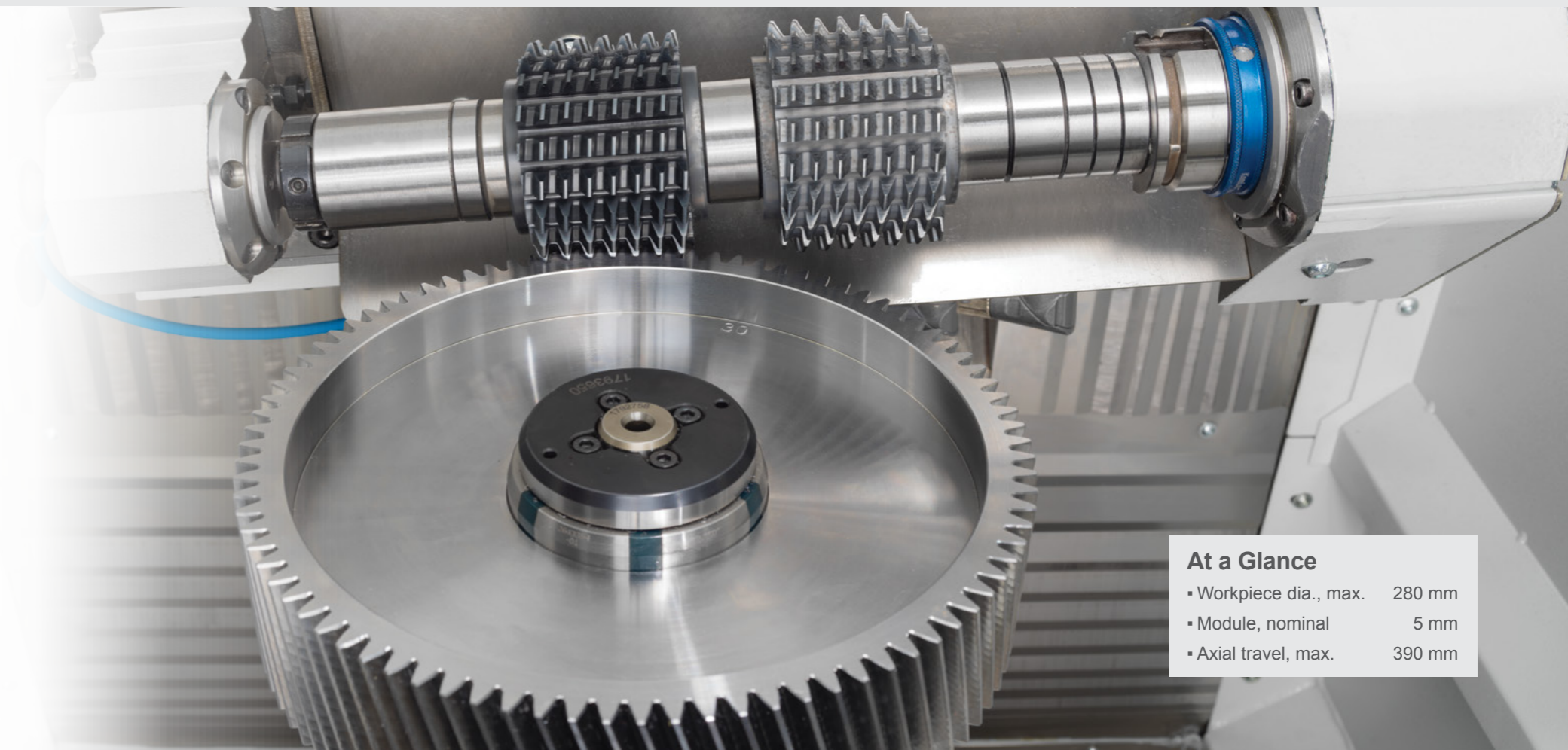

At a Glance	
• Workpiece dia., max.	280 mm
• Module, nominal	5 mm
• Axial travel, max.	390 mm



It wasn't long ago that cylindrical gear chamfering and deburring was almost an afterthought. Now the process ranks as high in importance as hobbing, shaping and grinding. Gear manufacturers, particularly those developing transmission gears for e-drive applications, recognize that anything less than a flawless tooth flank can result in premature transmission failure, less-than-optimal efficiency, and unacceptable noise. Thus, generating a chamfer to precise customer specifications is critical to minimizing the potential for sharp, brittle edges after heat treat, avoid edge load situations in the gear box as well as to steer clear of hardened burrs in the tooth flank prior to the hard finishing operations, which can greatly diminish tool life.

## 280CD: The Stand Alone Gear Chamfering Machine

For producers of spur and helical gears in sizes up to module 5 mm with 280 mm workpiece outside diameter and 380 mm shaft lengths, two breakthrough chamfering processes are now available in one machine: Chamfer Hobbing, ideal for high volume automotive and light truck applications, including EV gears and shafts; and Fly Cutter Chamfering for lower volume, small lot size jobber applications or prototyping. The new, stand-alone platform can perform both processes alike delivering either extreme efficiency or exceptional flexibility.



 Learn more about the new Genesis 280CD



## Lowest Tool Cost-per-Piece

When producing thousands, perhaps hundreds of thousands of the same part with challenging chamfer tolerances tool cost becomes an issue. Chamfer Hobbing with a Gleason chamfer hob provides the lowest possible tool cost-per-piece. The cutting tool has characteristics very similar to a conventional gear hob. A chamfer hob is used for each tooth flank with a tooth profile specifically designed for the particular chamfer form that is required. This design delivers greater flexibility: comma or parallel-chamfer forms are possible, as well as chamfers along the tooth edge only or including the root area. By cutting into the gap, burrs are avoided on the face side of the gears; no measurable burrs on the flank are produced, and downstream processes to remove the burr are eliminated.

Finally, the Gleason Chamfer Hobbing process offers tool shifting, which delivers increased tool life resulting in the absolute lowest tool cost-per-piece — just 1 cent for the typical automotive workpiece like an intermediate EV-gear.



Precise and repeatable burr free chamfers with Chamfer Hobbing.

“ Chamfer Hobbing an intermediate EV-gear can reduce tool cost per part to as little as 1 cent.

Gottfried Klein, Director of Product Management Hobbing, Chamfering and Shaving



mills the chamfer with the desired characteristics. Since each edge of the tooth is done separately and the chamfer size and angle depends on machine movements and not on the tool design, the process is quite universal. With just a relatively few different standard (i.e. inexpensive and globally available) insert blade sets and base bodies, a single tool can be used for different modules, pressure angles, and number of teeth. Size and chamfer angle can easily be programmed with the machine's intuitive GEMS® Machine Software.

## Easy Integration, Simple Handling

Manual or robot loading options allow a perfect integration into any production environment. The optional CNC tailstock will support clamping disc-type workpieces as well as shaft-type parts, using the fast, adaptable Quik-Flex® Plus Workholding System, which cuts workholding changeover to under a minute. The cutting chamfer processes are also available fully integrated with gear hobbing in the 160HCD and 280HCD Hobbing and



The newly developed GEMS® hobbing HMI allows intuitive and efficient operation of the entire hobbing-chamfering process chain.

Chamfering Machines, becoming a fully independent manufacturing cell. Shorter cycle times and more efficient, error-free operation also result from Gleason's most current GEMS HMI Hobbing Software, which makes setup and changeover more intuitive and

simpler to learn. This Human Machine Interface on the current Siemens control provides several new process options and guides the operator intuitively through the workflows of the stand-alone machine or fully integrated solution.

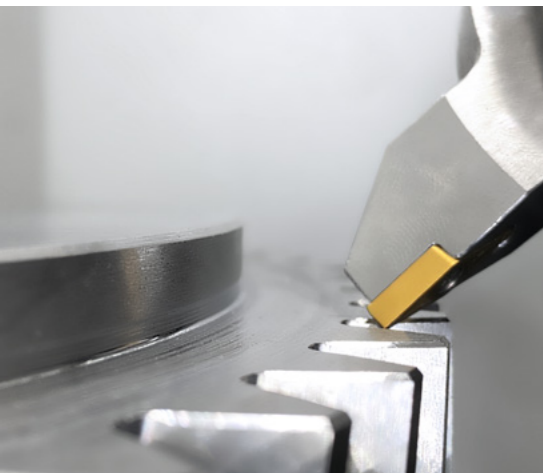

Flexible Fly Cutter Chamfering.

## Flexibility on the Fly

If a job calls for more chamfering flexibility, for example for small lot sizes or plenty of prototype work, Fly Cutter Chamfering is the right process choice. Having to change dedicated chamfering tools for each and every workpiece would be time-consuming and cost-prohibitive. Again, it's a

job for the 280CD because it has flexible Fly Cutter Chamfering on-board. The process generates a chamfer along the gear edge contour by synchronizing a fly cutter with workpiece rotation such that the cutter — generally a star-shaped body with 4 standard, replaceable indexable carbide inserts — contour



The new Genesis 280HCD with Chamfer Hobbing in parallel with hobbing.



**Gottfried Klein**  
Director of Product Management Hobbing, Chamfering and Shaving  
Gleason Corporation





# The 'Go Anywhere' Gear Company

New Gleason Genesis® 400HCD Hobbing Machine with innovative integrated Fly Cutter Chamfering helps Ontario Drive & Gear Ltd.'s Gear Division explore new opportunities.

The Gear Division of Ontario Drive & Gear Ltd. (ODG) keeps North America's wheels turning. If it drives, hauls, lifts, digs, plows – or goes just about anywhere in the case of ODG's famed ARGO amphibious vehicle – odds are it's with the help of gears and gearboxes from ODG. Their list of heavy equipment and vehicle customers is a Who's Who of North American brand names, requiring over 2,000 SKUs and the willingness to take on custom gear projects ranging from fine pitch to 500 mm in diameter, in small lots or volumes in the thousands. Suffice to say, this isn't your run of the mill, build to print gear shop.

### The Need for Speed

Be it large project or small, ODG approaches every customer challenge with the same question: 'How can we make it better?' A perfect example is the production of an important park



Hobbing and chamfering are done in parallel, thus eliminating significant non-productive time downstream.



Fly Cutter Chamfering enables a relatively few different standard insert blade sets to accommodate a wide range of gear sizes, geometries and chamfer requirements.

lock gear for the next generation of an iconic American sports car. The gear plays a small but important safety role. It mounts on the end of the transmission's output shaft, and when engaged by a 'pawl', prevents the shaft and drive wheels from turning when the car's in park and, conversely, prevents the car from accidentally being placed in park while driving. When tasked with producing this critical wear part, along with a transmission pump gear for the same vehicle, and both gears in volumes of 50,000 or more a year, ODG needed to re-think, and re-invent, the way it made these gears, recalls ODG Program Manager Nathan Riedel. "We discovered early on that we couldn't hob the park lock gear, due to its asymmetric, sprocket-like profile, with our existing equipment, so we would gash it instead, a far less productive process," explains Mr. Riedel. "We could hob the pump gear, but in both cases we would need to perform an important chamfering operation off-line, involving a significant amount of non-productive time for manual parts

handling, let alone the chamfering operation itself. The decision was made to invest in the new Gleason 400HCD, a hobbing machine with integrated cutting chamfer and debur, thus eliminating much of this non-productive time. Most importantly, the machine, with its Fly Cutter Chamfering technology, is very flexible, making it well suited for the high-mix, high-quality business we specialize in."

### Chamfering On the Fly

While Fly Cutter Chamfering has long been successfully employed on bevel gear cutting machines, it has just been adapted as a viable chamfering process for cylindrical gears on Gleason's Genesis® 400HCD Hobbing Machine, designed for workpieces up to 400 (optional 450) mm outside diameter and module 8 mm. The Fly Cutter Chamfer station, positioned at 90 degrees to the main hobbing work area, allows chamfering in parallel with hobbing, thus eliminating both the time, and potential for parts damage or human error associated with chamfering off-line.

“ We put a blank in and a little over a minute later, a finished part comes out, in less than half the time we needed previously...”

ODG Engineering Team

A four-station ring loader transfers workpieces between the machine's central worktable and the chamfering/deburring station, which is equipped with the aforementioned fly cutter. In the case of ODG, workpieces are loaded into, and unloaded, from the automation manually, but the machine is easily integrated with automated load/unload devices. Note that the machine is equipped with Gleason's Quik-Flex® Plus workholding system, a tool-less system that enables the operator to change over from one part to another in a fraction of the time it would typically take. The system can easily accommodate any of ODG's vast inventory of existing tooling through use of simple adapters – an important consideration in this 'high-mix' environment.

As Mr. Riedel noted, the new process offers significant advantages for improving chamfering flexibility as well as reducing machine and tooling costs as compared to chamfering on a dedicated, stand-alone machine. Fly Cutter Chamfering generates



a chamfer along the gear edge contour by synchronizing fly cutter and workpiece rotation such that the fly cutter – generally a star-shaped body with 4 standard, replaceable indexable carbide inserts – contour mills the chamfer with the desired characteristics. The Fly Cutter Chamfer process is continuously indexing and creates a cutter path that envelops the tooth geometry from the outside of the part in. All six axes in the chamfer unit are used during generation of the tool path, and the tool seeks to use the straight side of the indexable blades to optimize the process. The result is a precise and repeatable cut chamfer. Since each edge of the tooth is done separately and the chamfer size and angle depends on machine movements and not on the tool design, the process is quite universal. It can, with only a few sets of indexable carbide inserts, cover parts ranging from approximately module 1.5 mm to the maximum machine capacity of module 8 mm. The process enables just a relatively few different standard insert blade sets to accommodate a wide range of gear sizes, geometries and chamfer requirements.

### Plug and Play Performance

Most importantly, the 400HCD has, according to the ODG Engineering Team, hit the ground running, and helped ODG meet its ambitious

production targets for these first two parts right out of the box. It's a job shop workhorse," says Mr. Van Dorp. "In addition to these first two projects, we plan on running some of our larger diameter work on it in the range of 200 to 400 millimeters. Consistency is unmatched. We put a blank in and a little over a minute later, a finished part comes out, in less than half the time we needed for the previous processes. There's always the question too of how long will it take to train new people or to train people to use a new machine, but in that regard, we've been very happy with the user-friendliness of the machine." ODG Director of Program Management Steve Brown concurs. "It speaks a little bit to how much better this machine has to be when the shop is full of the competitors' equipment," says Mr. Brown. "It's easy to buy another product of similar manufacture. For ODG to deviate means there has to be some really good reasons to do so. It's checked all the boxes, right down to its



300GMS gives ODG the full range of inspection capabilities for a diverse range of projects, including noise analysis, fine pitch and even CMM-type measurement options.



surprisingly compact size. When you look at the 500 mm capacity machine right next to it, and compare its size to that of the Gleason, you find yourself asking, 'how can that be a 400 mm capacity machine?'"

### Adding Capacity to the Quality Lab

Downstream, in the Quality Lab, ODG was facing similar capacity constraints – no surprise given the high-mix nature of their workload and the increasing volume requirements of projects like those slated for the 400HCD. With two analytical inspection systems already running around the clock and on weekends, ODG made the decision to purchase a Gleason 300GMS Analytical Gear Inspection System along with the 400HCD.

"I demoed machines from three different vendors at the 2019 MPT Expo, and in the end I was very impressed with the user-friendliness of the 300GMS," recalls Mr. Van Dorp. "The programming is quicker than the older machines we have, and the 'rapids' are scary fast."

The 300GMS puts all the latest inspection capabilities into a single, compact platform for the complete inspection of gears up to 300 mm in diameter and shafts up to 500 mm in length. It delivers more speed and performance than earlier generations and competitive products. Like all the GMS series, it's equipped with the powerful Windows® 10 based GAMA™ application software, a proven, highly intuitive user interface to reduce programming and cycle times. GAMA, along with a full complement of Renishaw probes, gives ODG the full range of inspection capabilities it needs for its particularly

diverse range of project types, including noise analysis, fine pitch and even CMM-type measurement options. Like the 400HCD, it's surprisingly compact, an important consideration given the premium placed on floorspace at ODG.

### Open Borders, New Frontiers

With new technology, added capacity, and, finally, open borders post-pandemic, ODG Gear Division's Business Development Manager, Brendan Purcell sees the tremendous potential ahead for this fast-growing gear division. He and his team are poised to capitalize on the new technologies and the burgeoning 'can do' reputation ODG now has in many markets. "It wasn't long ago that we were 100% dedicated to the ARGO," says Mr. Purcell. "We now proudly participate in programs across multiple industries, from forestry and material handling to emerging markets in EV, medical, and robotics."



300GMS puts all the latest inspection capabilities into a single, compact platform for the complete inspection of gears up to 300 mm in diameter and shafts up to 500 mm in length.

### Ontario Drive & Gear Ltd.

Founded in 1962 by the Stieber family, Ontario Drive & Gear Limited operates from two facilities, with a total of 140,000 sq. ft. manufacturing footprint in New Hamburg, Canada. To satisfy the growing demand for its products and innovative developments, ODG has aligned its business strength in two divisions: the Gear and Vehicles.

For more information, visit: [www.odg.com](http://www.odg.com)







# Gears Up

Investment in new Gleason large hobbing and grinding machines is helping NGC become the powerhouse producer of transmissions for China's booming windpower industry.

In 2020, China broke the world record for most wind power capacity installed in a single year with 52 gigawatts (GW) of new capacity – doubling the country's annual installations compared to the previous year. According to the Global Wind Energy Council (GWEC), China now has more wind power capacity than Europe, Africa, the Middle East, and Latin America combined. The tremendous surge in windpower demand has been a windfall for Nanjing-based NGC, one of China's Top 10 leaders in the production of transmissions for domestic as well as global applications. Sales increased 58% in 2020, and there are now over 80,000 NGC sets of gear boxes, and 460,000 variable pitch and yaw gearboxes, installed in 30 countries in the wind turbines of all the big-name domestic and international manufacturers, including GE Renewable Energy, Siemens, Gamesa, Vestas and Suzlon. When it comes to windpower, NGC transmissions are everywhere, with a justifiable reputation for high reliability, whether operating in extreme low temperatures or high altitudes, onshore or offshore, and with sizes ranging from 1.5MW to 8MW applications.

Nor is windpower all that NGC is known for. NGC gearboxes for urban rail transportation, for example, are in high demand, for everything from the Grand Paris Express project to Australia's Perth Subway system, to China's new Standard Metro Train, rolled out in Zhengzhou in 2021 and representing China's vision for a new generation of standardized urban transportation.

### Bigger Gears, More Capacity

With demand surging for the large, very high quality external and internal cylindrical gears of the type needed for today's windpower applications, NGC has greatly increased capacity by adding to its already impressive array of Gleason technology at its Nanjing factory. Since installation of its first Gleason gear grinding machine in 2003, NGC has purchased approximately 200 Gleason machines for both cylindrical gear and bevel gear manufacturing. Most recently, NGC has ramped up its gear production for, in particular, very large offshore wind turbine applications with the latest Gleason P3200 Hobbing Machine and P3200G Grinding

Machine, along with smaller Gleason P600 Hobbing and P600/800G Grinding Machines for windpower and rail applications.

According to NGC officials, these large Gleason P series machines seem tailor-made for NGC and their high throughput and quality requirements.

The P3200 Hobbing Machine, for example, provides a range of hob head selections so NGC can configure the machine with the perfect fit for their wide range of internal or external spur or helical involute gears and shaft applications. For maximum flexibility, changing from external to the IFK3 internal hobbing head is easily executed by the operator. The IFK3 head comes with an integrated swivel axis for high helix angles and face widths up to 1000 mm without interference – large enough to accommodate the ring gears needed for the gearboxes common to the larger 8MW wind turbines used offshore.



New Gleason machines have added the capacity NGC needs for producing the larger gearboxes now in great demand for offshore wind turbines.



Similarly, the P3200G Profile Grinding Machine features different grinding heads for both external and internal gears and covers different power and grinding wheel diameter ranges.

The P3200G also excels in the reduction of costly non-productive time. In the case of these large gears, many hours are typically required for workpiece setup, parts programming, parts inspection and grinding. Setup time on the P3200G is greatly reduced through use of Gleason's well known runout and wobble compensation, which automatically compensates radial runout and wobble of gears with imperfect alignment, rather than relying on an operator and a painstaking manual process.

On-board inspection of both internal and external gears is fully integrated, saving enormously on the time needed after the grinding is complete to evaluate gear characteristics –

a process that can take hours in the Quality Lab.

These larger Gleason machines feature optimized machine components like the machine bed, patented guideways and the latest drive technology to ensure high performance. The guideways, a combination of slideway and anti-friction guideway, provide the ideal combination of stiffness and damping characteristics. This ensures substantially higher productivity and improved gear-cutting and grinding quality. On the grinding machine, large doubleworm index drives with a large number of teeth combined with hydrostatic table bearings allow slow rotational speeds while maintaining the highest quality. This design accommodates significant variations in workpiece moments of inertia.

Finally, both of the new machines are operated with the latest generation

Siemens CNC controller, with shop-oriented, user-friendly Gleason dialog program to support the entire machining process. The machine operator calls up the required workpiece, tooling and technological data on a Windows® based user interface. The NC part programs are generated automatically, eliminating the need for time-consuming programming.

### In Summary

NGC is a company built for this moment in time, as it helps the world enter an exciting new era of clean, sustainable energy production and efficient energy-saving transportation by rail. According to NGC officials, Gleason has proven to be the right partner to help fulfill its ambitious objectives. "Gleason not only provides high-quality machining equipment, but also follow-up services, applications, tools and other technical support from nearby Suzhou. We're looking forward to what comes next."

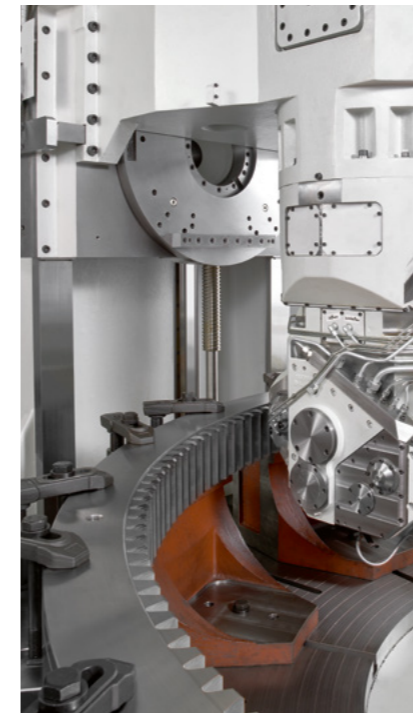

IFK3 internal hobbing head with Integrated swivel axis allows for high helix angle and face width up to 1000 mm without interference.



New P3200 Hobbing Machine adds much needed capacity for larger external and internal gears and shafts.

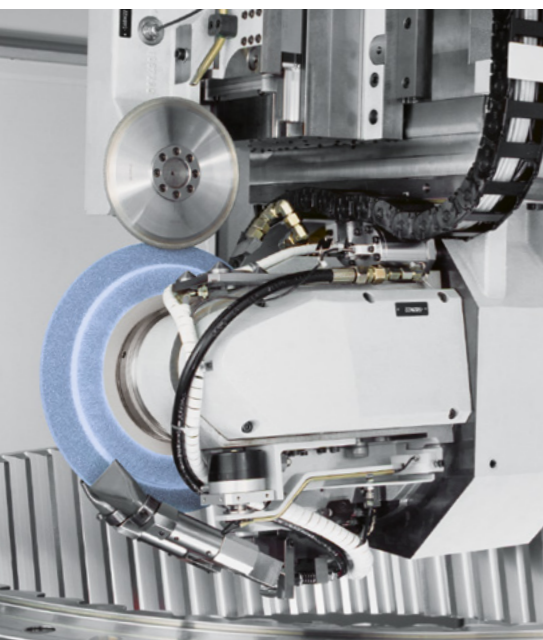

Internal profile grinding head equips NGC's new P3200G for more power, speed and versatility.

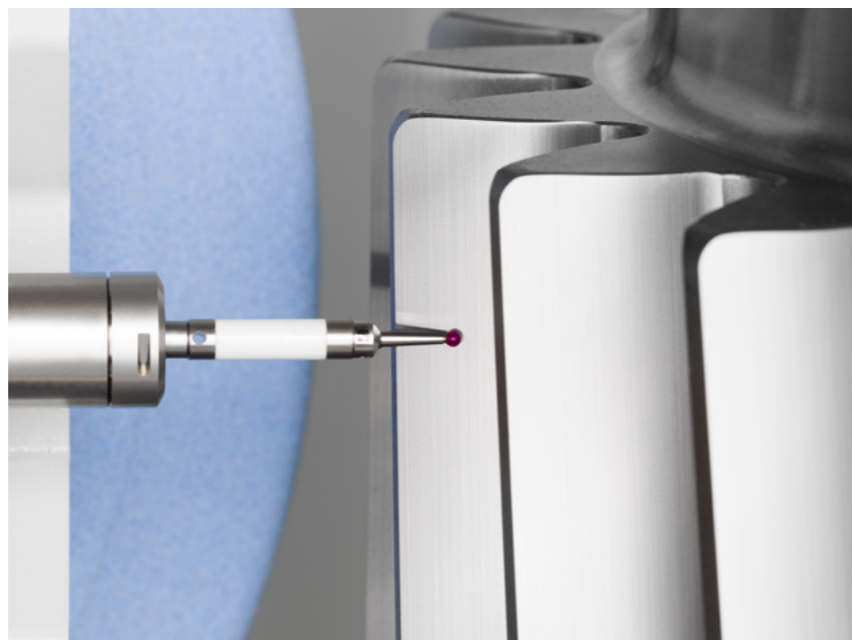

The P3200G Profile Grinding Machine has an integrated inspection device for testing external and internal gears. The inspection data can be evaluated according to all common industry standards.



### About NGC

NGC was founded in 1969, is headquartered in Nanjing, P.R.C., and has branches around the world. The company employs more than 6,000 people, forming a global network integrating production, R&D, sales, and service. NGC is listed on the Hong Kong stock exchange under the name "China Transmission".

For more information, contact: [www.ngcgears.com](http://www.ngcgears.com)



Any Questions?

**Ryan Yang**  
Managing Director of  
Gleason Sales China

Your Contact in China  
[yang.zhengyu@gleason.com](mailto:yang.zhengyu@gleason.com)



# A Giant('s) Success Story



With installation of a Gleason P6650G Profile Grinding Machine, the largest machine of its kind in Europe, France's CMD separates itself as a preeminent global source for the very largest, highest quality cylindrical gears.

André Citroën always dreamed big. The future industrialist, said to have been inspired as a boy by the works of Jules Verne and the technological marvels of the Eiffel Tower and the 1889 World Exhibition,

would soon be world renowned for engineering feats of his own. While Citroën is best known for building his namesake automotive company – the first in Europe to employ the assembly line practices of Henry Ford – he is also credited with inventing the double helical gear (and incorporating the double helical pattern into the iconic Citroën logo).



Watch the Inauguration at CMD



CMD, the company he founded in 1901 to produce these gears is still going strong today as part of the industrial Groupe CIF created in 1831, and today dreaming big – perhaps bigger than Monsieur Citroën ever imagined. The company is now the proud owner of Europe's largest profile grinding machine – a Gleason P6650G designed to produce gears weighing as much as 70 tons with diameters in excess of 6 meters. The machine arrives just in time to add much needed capacity for the largest helical, planetary and worm gears – in everything from cement to chemical plants, mines to steel mills, water treatment to wind power.

### Adding Capacity, Reducing Risk

In the specialized world of giant gear production only a relative handful of companies like CMD dare to tread, and the risks inherent in purchasing machines that can cost in the millions of euros are enormous. For CMD, embarking on its ambitious expansion plans three years ago, all roads led to Gleason. "CMD has been running a Gleason P4000G Profile Grinding Machine since as far back as 2004, often for three shifts a day and even on weekends for almost 17 years," says CMD Deputy Managing Director Frédéric Bellot. For Monsieur Bellot, and teammates Frédéric Cornu, Quality Products and Continuous Improvements Manager, and François Lenglet, Project Manager, this long and productive partnership made Gleason the obvious choice for a comprehensive package that included not only the giant new P6650G, but a much smaller P600/800G Profile Grinding Machine and software upgrades on the older P4000G and several other Gleason machines.

Additionally, the resources of Gleason Sales (France) were available for close



support from day one, says the office's Managing Director Philippe Laffitte. "Given the complexity of this project, we committed our nine-person team at the outset to its success, as well as hiring an additional service technician close by that could be at the CMD facility on a moment's notice," Philippe Laffitte says. "Working hand in glove with our colleagues in Ludwigsburg where the equipment originates was the only way a project of this magnitude could have been managed so successfully."

### Big, Fast and Agile

Where the largest machine tools in the past were often dedicated to performing a relatively few specialized tasks, the P6650G represents a new generation of fast and agile machines – ideal for CMD's particularly diverse product mix and increasingly tight lead times. While Gleason's largest 'catalog' P series machine has a maximum workpiece diameter of 6000 mm, the P6650G extends this range another 650 mm. The machine

comes equipped with grinding heads for the production of both internal and external gears and a bore-type worktable to help accommodate pinion shafts with lengths up to 6000 mm. With some of these parts weighing as much as 70 tons, CMD cites the importance of the worktable's design, and the use of large double worm index drives combined with hydrostatic table bearings that allow for slow rotational speeds and significant variations in workpiece moments of inertia while maintaining the highest quality. Additionally, utilization of the latest digital drive technology, direct measuring systems on all linear axes as well as precise thermal stabilization by means of a special cooling system provide optimum accuracy under varying conditions.

Where the P6650G really excels, according to CMD, is in the reduction of costly non-productive time. In the case of the very largest gears, many hours are typically required for workpiece setup, parts programming,



parts inspection, grinding wheel dressing and anything else that isn't actual profile grinding – and profit-making.

Setup time, for example, is greatly reduced through use of Gleason's well known and proven runout and wobble compensation, which automatically compensates radial runout and wobble of gears with imperfect alignment, rather than relying on an operator and a painstaking manual process.

On-board inspection of both internal and external gears is fully integrated, saving enormously on the time needed after the grinding is complete to evaluate gear characteristics – a process that can take hours in the Quality Lab.

In its drive to reduce non-productive time, Gleason has also optimally positioned the dressing unit to shorten dressing cycles. The machine also employs Gleason's proprietary Power Dressing process, which reduces actual dressing time to just a fraction of what's typically required conventionally.

**Brawn – and Brains**

The P6650G's formidable intelligence stems from the latest Siemens controller and a new user-friendly Gleason dialog program that supports the entire machining process. The operator simply calls up the required workpiece, tooling and technological data on a Windows® based user interface, with part programs being generated automatically, eliminating the need for time-consuming programming. The software presents graphical displays to provide visual information to the operator including lead and profile modifications. The software computes a proposed grinding process utilizing experience-based data.

This powerful operating software, in conjunction with an on-machine measurement probe, helps to optimize stock division before profile grinding begins, thus improving tool life and ensuring the best possible profile grinding results. Then, the software automatically generates the complete grinding process sequence, suggesting a number of different strategies, designed to save time and produce the optimum finished part.



Grinding heads for external and internal gears accommodate dressable grinding wheels for maximum flexibility, CBN wheels for maximum stock removal.



Integrated on-board inspection of internal and external gears to facilitate stock division, improving tool life and part quality.

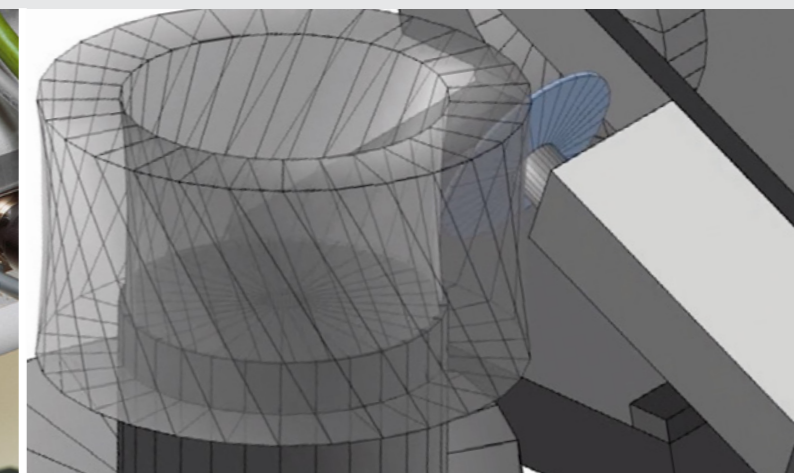

Wobble Compensation System, which automatically compensates radial runout and wobble of gears with imperfect alignment.

**In Summary**

April 21, 2021 commemorated a proud moment in CMD's long and illustrious history, with presentation of the new Gleason P6650G at CMD's Cambrai, France facility by company and Groupe CIF executives and local and area government officials. Nestled in on a special foundation and poised to produce even larger variations of the high quality parts CMD is known for, the P6650G marks the beginning of an exciting new era for the company. "Together, with Gleason, we worked through the challenges that naturally arise on projects of this scale," concludes CMD's Frédéric Bellot. "Along the way, the Gleason team always worked hard to find solutions. Not even the pandemic slowed us down. With this added capacity, we are excited for what's next."

**About CMD**

CMD, founded by André Citroën in 1901, became part of Groupe CIF in 2005. With nearly 200 years of experience, the group provides its customers with customized solutions, adapted to their specific needs in Drive, Casting and Engineering.

Expert in high torque, low speed power transmission, CMD is the number one manufacturer of mechanical transmission equipment in France, with two production facilities and 400 employees. CMD designs, develops, produces, installs and provides maintenance of power transmission solutions adapted to the specific requirements of each customer as parallel helical gears, planetary gears, wormgears, couplings, rotors, etc.

For more information, contact:  
 CMD  
 539 Avenue du Cateau  
 59400 Cambrai, France  
 +33 (0)3 27 73 53 11  
 contact@cmdgears.com  
 www.cmdgears.com

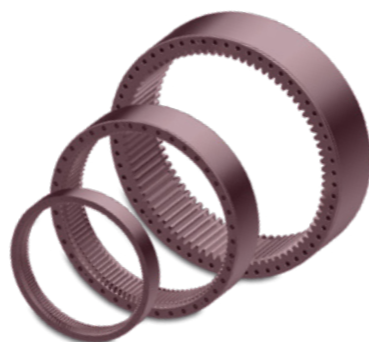
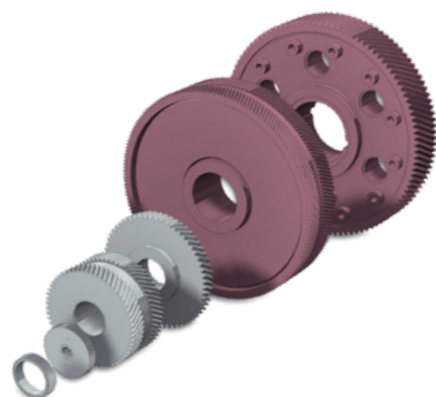



# Master Class

When it comes to application versatility and flexibility, the new 1200G is in a class of its own.

## At a Glance

- Several external and Internal grinding heads.
- High performance grinding head with 150 Nm torque and up to 450 mm wheel diameter.
- Direct driven machine table with Auto Servo Tuning (AST).
- Module range: 0.5 to 35 mm.
- Workpiece diameter: up to 1,250 mm.
- High axial speeds up to 14.5 m/min.
- Compact machine footprint and excellent accessibility to the work area.
- Integrated gear measurement for both external and internal grinding.
- Many innovative technology features.

With 1,300 mm axial travel, the 1200G covers the applications most common in this size range. If large profile depths and high grinding performance are required, e.g. in wind power applications, then a performance grinding head with powerful 150 Nm torque and maximum wheel diameter of 450 mm is available.

The 1200G's axial speed, particularly important to ensuring short grinding times, is 10 m/min, exceeding the performance of competitive machines by up to 66%. Optionally, even 14.5 m/min is available, setting a new benchmark in this class.

Additionally, the design of the direct-drive table allows for high dynamics and, through the use of Gleason's proprietary Auto Servo Tuning (AST), the capability to handle a wide variety of workpieces, weights and inertias.

The package is further enhanced with a wide range of technology features that includes innovative run-out and wobble compensation, degressive and A(X) infeed strategies, smart dressing, stock-specific grinding and/or worm grinding.

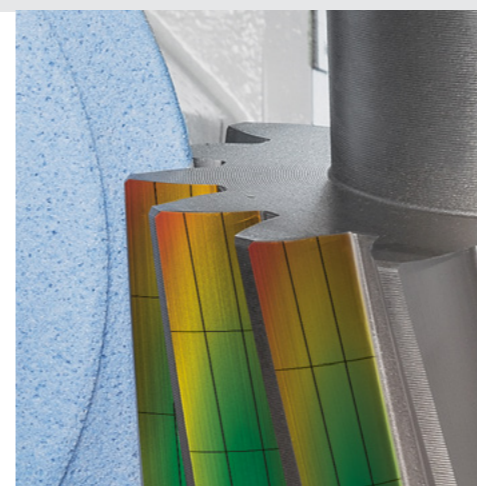

Twist controlled grinding.

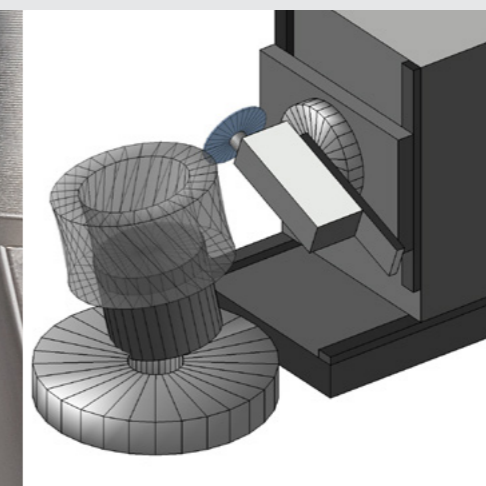

Runout and wobble compensation.

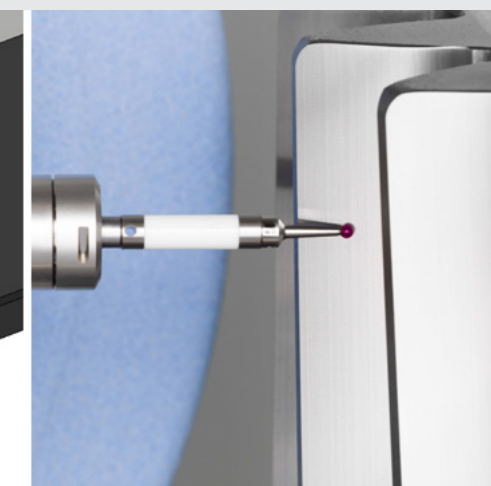

Stock specific grinding.

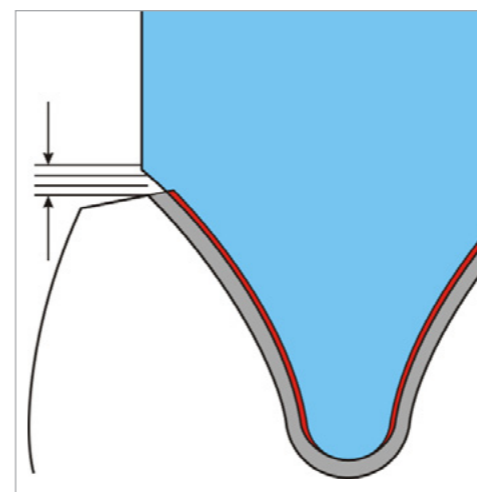

A(X) infeed strategy.



Smart dressing.

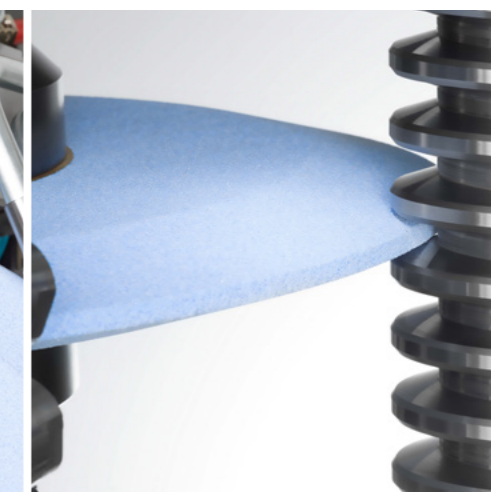

Worm grinding.



More Info About  
Technology  
Features

“ The 1200G's unique quality features make it truly the benchmark in its class. ”



Dr. Antoine Türich  
Director of Product  
Management  
Hard Finishing Solutions  
Gleason Corporation

See the 1200G  
in action





# The Economical New Pentac Ecoblade RT

Face milling cutter head design evolves: Pentac® Ecoblade RT offers significant savings for face milling of bevel and hypoid gears.

## At a Glance

- Cutter system with radial spacers (equivalent to parallels).
- Stiffer blade seating than rectangular parallels (RSR® etc.).
- Highly economical small size blades.
- Real radial trueness.
- Optimal chip formation.
- Chip packing elimination.
- Reduced process heat.
- Ground slots with stiff seating (instead of wire EDM).
- Productivity higher than rectangular blade cutters (RSR® etc.).
- Part quality suited for single rotation grinding.

With its introduction in 1960, the Hardac® cutter system represented a significant breakthrough for the single indexing process using face milling cutters. Hardac offers radially truing and a large range of radii that could be covered with one specific cutter size through the use of parallel spacers between slot bottom and blade. The parallel spacers allow positioning of outside and inside blades at the desired point radius,

given by the summary. The truing screws are used for the precise radial fine positioning of the blades as well as eliminating the radial runout from blade to blade. While Hardac blades provide easy radial adjustability, they are very inflexible when cutting edge geometry features need to be changed and require new blades for different specifications. More recently, with the development of the Gleason Power Cutting process and the use of carbide stick blades, the requirement for exceptional

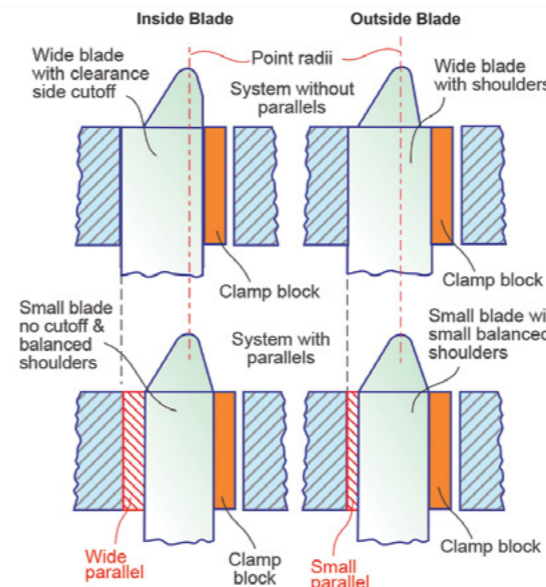
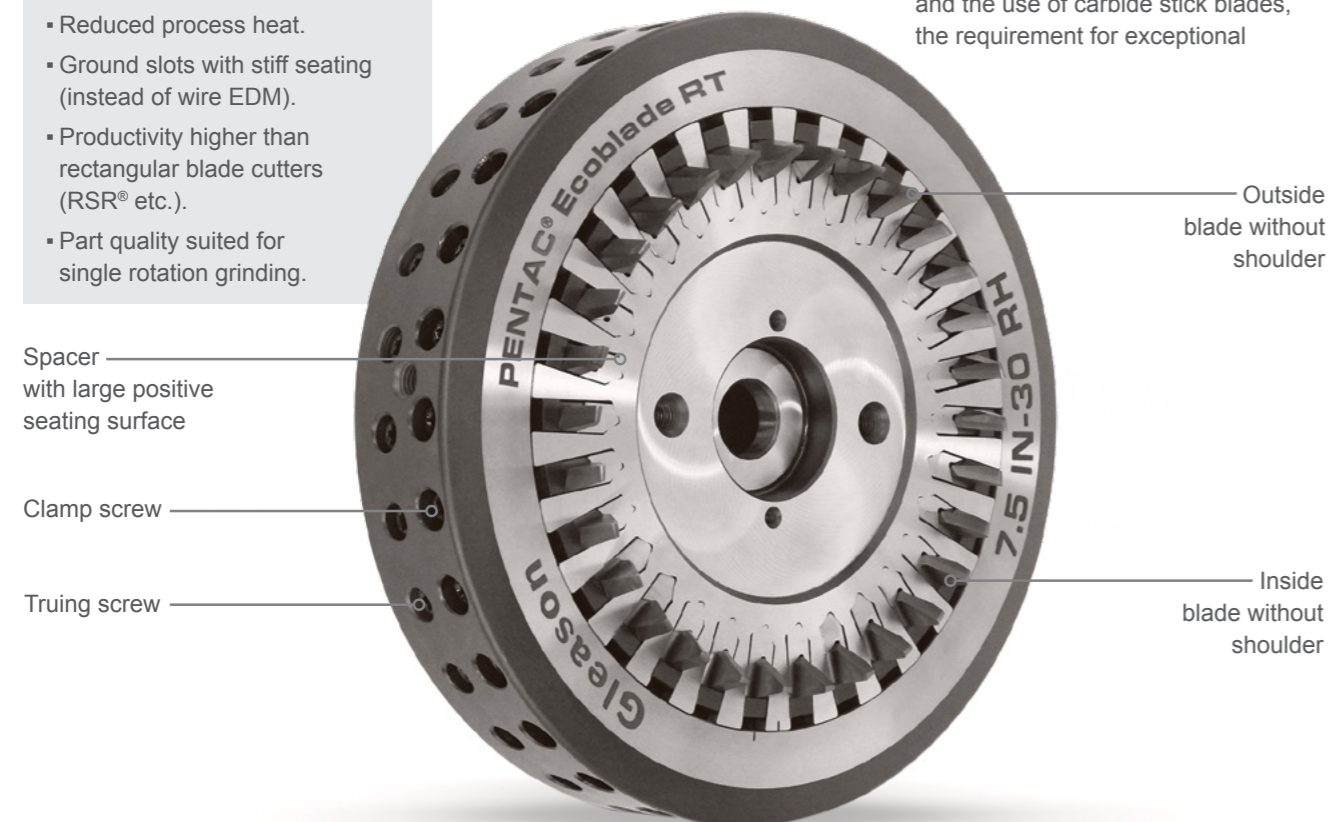

Pentac Ecoblade RT (bottom row) uses small blades with parallels, thus saving on carbide costs and providing better balance as compared to wide, unbalanced blades (top row).

blade seating stiffness initiated the development of a new cutter system with positive seated blades. This cutter head with five-sided slots was called Pentac. Conventional wisdom at the time was that the highest seating stiffness of blade sticks in a cutter head slot could only be achieved by eliminating the use of parallel spacers. In the Pentac Plus RT, used for face hobbing, this works very well. Face hobbing designs require only small amounts of cutter head tilt without any significant blade radius adjustments. This is the reason face hobbing cutters use rather small blade widths without parallel spacers. In order to cover the required range of diameters in face milling, without the use of parallels, each cutter diameter requires two Pentac cutters, one called "nominal" and the second called "completing". The slot bottom radii of those two cutters were several millimeters different and the blades had additional width. This provided the required flexibility for most applications. However, in many five-cut conversions from the older Hardac cutter system, it wasn't possible to

apply a Pentac cutter due to the radial restrictions. Another drawback with this "non-parallel" face milling cutter system is the need for wider blades which of course adds to blade blank cost and blade re-sharpening times.

### A Better Way: Pentac Ecoblade

The new Pentac Ecoblade RT cutter system preserves all the advantages of positive seated Pentac blades and, most importantly, real axial and radial trueness. A new spacer block design provides the highest possible radial and tangential stiffness, combined with the most economical blade sizes. These Pentac Ecoblade RT spacer blocks are not traditional parallels. In order to preserve the advantages of positive seated Pentac blades a new adaptor prism (spacer block) uses a two sided wedge seating between spacer and cutter head slot and the traditional Pentac seating at the opposite side. This design provides the highest possible radial and tangential stiffness. The tangential stiffness transfers the cutting forces through the lower part of the slot wall into the cutter body. Truing ability

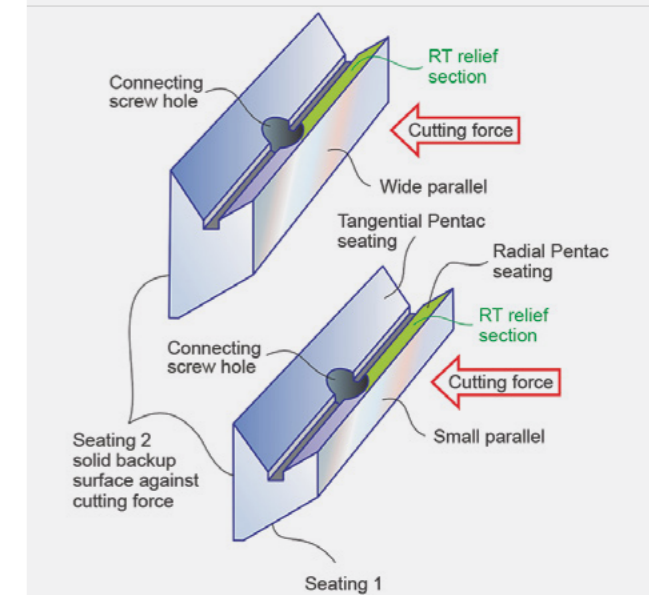

The trueness of the new cutter head with spacer blocks is identical to the proven Pentac Plus RT cutters, delivering excellent surface finish and tool life.

is built into the spacer. The Pentac seating in the spacer blocks has a ground relief which is identical to the radial relief in Pentac Plus RT cutter slots.

Most importantly, the Pentac Ecoblade RT cutter head reduces the number of blade groups by one or two. This increases stiffness and creates more space to minimize or eliminate chip packing altogether, thus increasing cutter productivity. While having two more blades would, in theory, increase productivity, the reality is that the potential for chip packing or cutting vibration when using more blades requires that tradeoffs have to be made. Pentac Plus Ecoblade RT is the cutter system without compromises and tradeoffs.



**Prof. Dr. Hermann J. Stadtfeld**  
Vice President  
Bevel Gear Technology  
and R&D

The Gleason Works





# Fast and Agile Production of Truck-Size Bevel Gears

New Phoenix® 500C Bevel Gear Cutting Machine makes fast, agile production of 'truck-size' bevel gears a reality.

The many benefits of high speed, easy operation and automation aren't just the domain of smaller machines any longer. Now you'll find them in a bigger package for larger gears. Gleason's new Phoenix® 500C Bevel Gear Cutting Machine has been designed from the ground up to bring much-needed speed, flexibility and ease of use to the

higher volume production of precision bevel gears for trucks, buses, and other like-size applications. The end result is the highly productive solution you've always wanted for your larger gears, cutting cycle times, ensuring precision, driving down cost and making life easier for your operators and maintenance people.

## A Better Design

- A Work spindle rotation
- B Root angle
- C Cutter spindle rotation
- X Linear axis
- Y Linear axis
- Z Linear axis

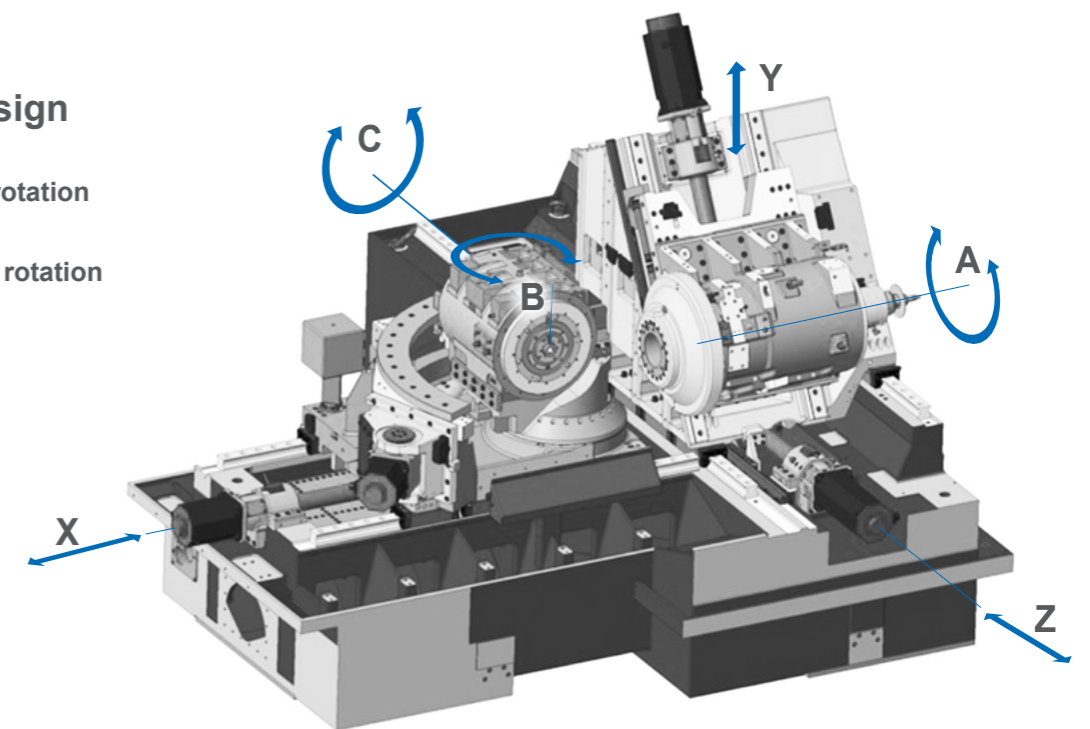

## Fastest in Its Class

Lift the hood on the 500C and you'll find a machine design very different from its predecessors, or competitors for that matter. Elimination of the conventional wall-mounted column, for example, helps 500C deliver exceptional static and dynamic stiffness to meet today's higher volume, precision gear requirements. Machine motions are inherently shorter and faster too, with a design that puts cutter and workpiece in closer proximity, and axis acceleration is three times that of existing machines. All of these factors, combined with high speed, high torque direct drive cutter and workhead spindles make 500C the perfect platform for dry Power Cutting and the use of the latest, most productive cutter systems, including Pentac®Plus, Pentac®Plus RT and new Pentac® EcoBlade RT for face hobbing and face milling.



But what really sets 500C apart is its ability to automate larger gear load/unload to speed throughput, optimize the process flow – and lift the time-consuming burden from operators that are already stretched thin. The labor-intensive manual process, that in the past would take many minutes to perform, now can be reduced to just 22 seconds chip-to-chip through use of a Gleason robot to automate load/unload of workpieces as large as 150kg. The 500C's extended Z-Axis enables the workspindle to travel rapidly to the load/unload station at the rear of the machine for fast, automated exchange of a finished workpiece with uncut blank. The robot is equipped with multiple grippers for unloading and loading the 500C. This allows the robot to unload a finished part with one gripper, swivel around and load an uncut blank with a second gripper, thus improving productivity. Note that this automation can be easily integrated with Gleason stackable tray and palletized automation solutions to minimize even further the operator's burden.

Auxiliary processes can be added too to the automation to meet specific customer requirements, including washing, laser marking, chamfering/deburring, and inspection. And stock division can be performed outside the work chamber for precise part orientation in advance, and in parallel to, cutting so no production time is lost. Additionally, serial chamfering of the heel can be optionally performed in the work chamber, thus saving the time usually required as a separate, often manual, operation downstream. The unit, positioned above the cutter, retracts/extends to keep work area clean and uncluttered.



Robot loader automates the typically manual load/unload process of larger gear blanks and finish gears, cutting load/unload from minutes to as little as 22 seconds. The robot's dual grippers unload a finished part with one gripper, then swivel to load an uncut blank.

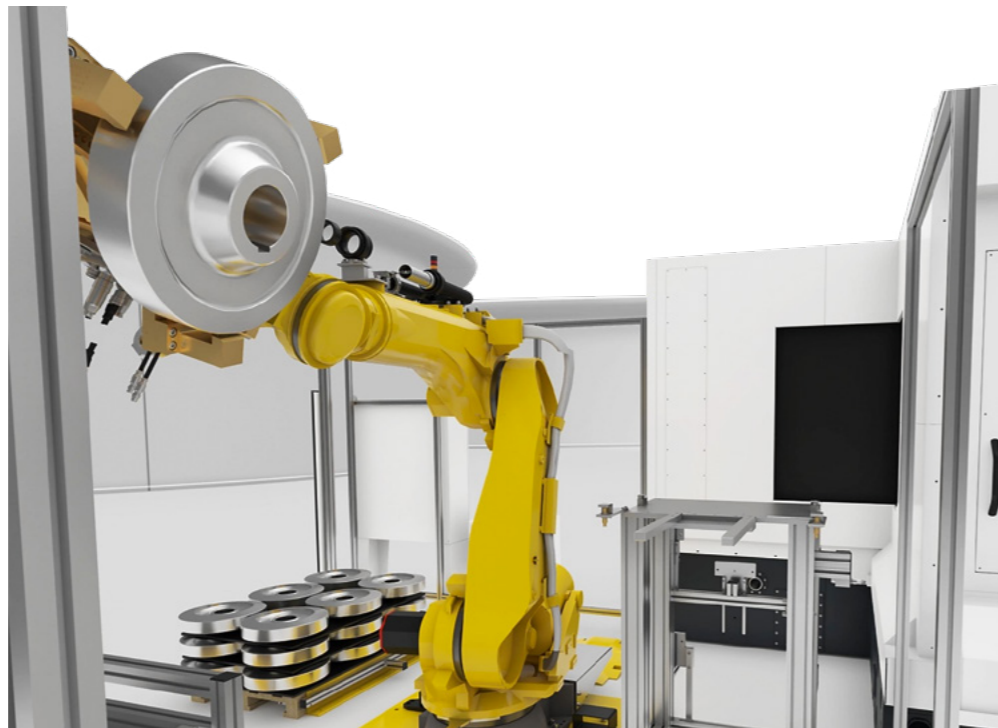

Operator works at floor level with no platform required to make cutter and workpiece changeover easier and faster.



New Gleason GEMS Bevel Machine Software makes set-up and operation easy and intuitive for the operator.

500C combines this ground-breaking automation with Gleason bevel gear quick change tooling to eliminate much of the additional non-productive time that was once required to change over for different parts – while at the same time achieving exceptionally high accuracies. The workholding is also easily adapted to the customer's existing workholding to save on tooling costs.

### New Design, Easier Operation and Maintenance

The 500C has been designed to make the day to day tasks of both operator and maintenance personnel faster and more efficient. 500C puts the operator at floor level with no platform for fast, easy access to the work area, with minimally short reach and open design for easier access to the cutter and workpiece. Serviceability is enhanced as well, with easy access, superior protection of rails and ball screws, and the use of robust, precision components throughout.

Hot chips collect well below the cutting zone away from sensitive machine surfaces and components. The standard chip conveyor can be positioned to meet the customer's floor space requirements. An optional small dust vacuum system removes airborne particles when dry cutting.

### Fast, Flexible and Closed Loop

While 500C has been designed to address the needs of producers of larger bevel gears in higher volumes, it also offers greater flexibility, for all types of face and straight bevel gears, SRH, Zerol®, spiral and hypoid gears, couplings and even straight bevel gears with front hubs. Whatever the application, the new Gleason operating software and network capabilities allow easy integration into any modern production environment. Most importantly, Gleason software makes setup and operation easy and intuitive, and can interface the 500C with Gleason's GEMS® Smart Loop Manufacturing, which connects all

process steps, from gear design to the final, optimized gear in a single-system approach – for worry-free and intelligent gear production.

### In Summary

Fast, flexible, highly automated production was once limited to smaller bevel gears produced in high volumes. 500C has changed the paradigm, just in time to bring more speed and efficiency to your larger bevel gear production.



Learn more about the Phoenix 500C



**Uwe Gaiser**  
Dipl.-Ing (FH)  
Director Product Management  
Bevel Gear Solutions

Gleason Corporation



# Digital Service for Transformers

Digital technologies are transforming the service landscape, enabling manufacturers to work around the worldwide pandemic without missing a beat.

With the onset of the worldwide pandemic, business activity as we knew it before ground to a halt. Supply chains were disrupted, travel restricted and many employees began working remotely. Manufacturers have been forced to adapt to a whole new world on the fly and almost overnight; a world where the tried and true, face to face, hands-on interaction between suppliers, customers and fellow teammates can't be done in traditional fashion.

**Necessity: The Mother of Invention**  
The old expression holds true today. The global pandemic has ushered in the use of a new generation of digital tools that are transforming the workplace and the manufacturing environment. While 'Zoom' is perhaps the most obvious example a host of other technologies now exist that have enabled Gleason to meet our customers' requirements for machine service and support – anytime, anywhere – and on a level exceeding what was the 'norm' pre-pandemic. Our customers have quickly adapted to the new world of digital service, and support requests via our digital tools have grown exponentially as compared to 2019. And there's no going back!





### Gleason Connect Cloud



#### Staying Connected Via the Cloud

Gleason 4.0 digital initiatives have been at the forefront of virtually every aspect of our business dating back many years, so we were fortunate to have had most, if not all of these digital tools already in place. As a result, our customers could seamlessly connect with Gleason service and support experts via Gleason Connect Cloud, our online portal, 24/7 and from anywhere in the world. Through Gleason Connect Cloud, customers can access machine history, technical documentation, wear and spare parts lists, manuals and service reports anywhere, at any time.

With Gleason Connect+, problems in the field can be evaluated 'live' by Gleason experts and resolved in real time with visual directions to the customer's service technician, via Smart Glasses or an existing smart device providing video live streaming and Augmented Reality.

Older machines can be serviced remotely as well, with the retrofit of a Gleason Connect box, which provides a secure digital connection between your machine and our technical support team for remote analysis and troubleshooting.

### Gleason Connect+

#### Gleason Connect+: Seeing is Believing

With travel restricted and manpower at a premium, keeping machines up and running productively has never been more challenging. In the pre-pandemic world, a 'down' machine diagnosis and repair usually meant a service call. Not any longer.



### Gleason Modernization Programs

#### Looking Forward, and Back

Gleason Service not only maintains and repairs your machines, we also have an extensive modernization program ready: from smart retrofit and overhaul to complete remanufacturing. Nobody knows the machines better than Gleason, the original designer and manufacturer. Available for all machines, whether metrology, gear cutting or automation, thanks to our global manufacturing locations also in your area.



### Gleason Fingerprint™



#### e-Ticket Requests Travel Faster

For quick, effective 24/7 online service requests and spare parts for your Gleason machine, there's nothing like e-Ticket. It's faster and more efficient than telephone or e-mail. With your Gleason machine model and serial number ready, your service or tooling request starts immediately via QR Code or at gleason.com.

#### Taking a Gleason Fingerprint™

While these digital tools help to quickly resolve problems as they arise, Gleason Fingerprint can actually solve them before they even occur. Similar to a human's fingerprint, machines have a specific mechanical fingerprint too. It's unique to the machine and can show the machine's true condition well before a significant problem develops. It can be used to retrieve a direct comparison of the machine's current status with the ideal/normal status on the user interface of Gleason machines. Fingerprint information can then result in faster, more detailed diagnostics and more proactive service actions.

#### Knowledge is Power

While the traditional 'learning environment' has, out of necessity, changed as a result of the pandemic, Gleason training resources are more robust, and more 'digital', than ever before. For example, Gleason's popular 'Home Trainer' Webinars were introduced during the pandemic to keep our customers connected, and learning, from home. Now, these Gear Trainer Webinars continue to provide an exceptional learning experience, and cover a variety of topics on bevel and cylindrical gear manufacturing technology. Gear Trainer Webinars are moderated live by gear technology experts and include integrated Q&A function.

For a more comprehensive learning experience, with curricula covering more than 115 different topics, Gleason offers its Gleason Academy.

While these training events have traditionally been conducted either at Gleason plants, offices or an independent site, an increasing number of classes are now being held in a virtual classroom setting, and designed to deliver the shorter, more condensed, intensive learning experience that's ideal for the on-line classroom.

### Gleason Academy



### Gleason Trainer Webinars



**Robert Peyr**  
Director Product Management

Gleason Global Services



Get Your 24/7  
e-Ticket  
Connection



# Mute Transmission Noise

E-Drive Design with KISSsoft and RecurDyn

KISSsoft AG (a Gleason Company) and FunctionBay GmbH present a new, seamless approach to design, analysis and optimization of the NVH behavior of gearboxes used in e-drive systems.

The workflow starts with a base transmission layout within the KISSsoft® software environment. It is followed by a strength and stress analysis taking all relevant system deflections into account. Macro and micro geometry sizing are executed, followed by a Loaded Tooth Contact Analysis (LTCA). The dynamic behavior of the complete system (modal analysis and forced response) will be calculated.

Finally, the load files and all relevant geometrical information

are transferred from KISSsoft to the Multibody Dynamics (MBD) software: RecurDyn from FunctionBay.

Within RecurDyn the NVH simulation model is automatically generated based on the data supplied by KISSsoft. It includes flexible housings, pre-calculated loads and all components representing the internal mass distribution of the system.

The necessary simulations are also run automatically. An acoustic post-analysis can be performed by

evaluating the calculated Effective Radiation Power (ERP), the Sound Pressure Levels (SPL) or by inspecting the related Campbell diagrams and more. If an optimization loop is required the described workflow can be shortened by adjusting the gear design in KISSsoft and just updating the new calculated load files in RecurDyn.

KISSsoft and FunctionBay will happily show you how to mute your e-drive transmission in a live demonstration.

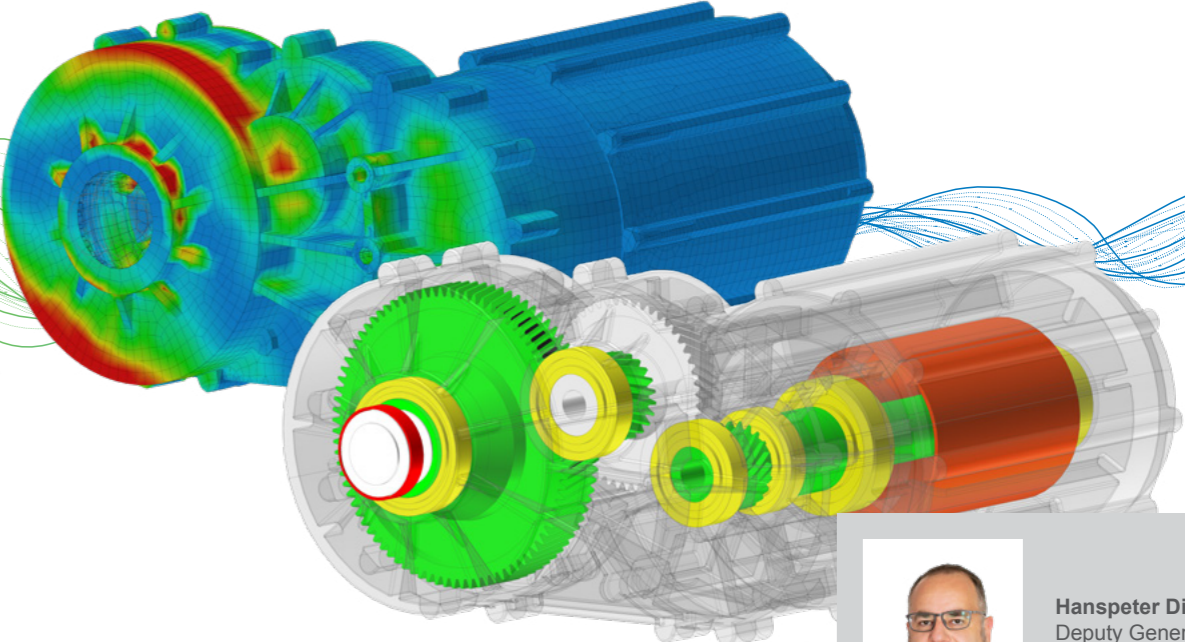

Hanspeter Dinner  
Deputy General Manager  
KISSsoft AG

Watch the workflow video 

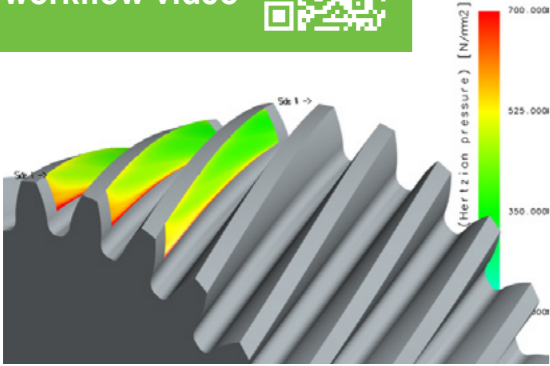

Hertzian pressure distribution on tooth flanks without modifications.

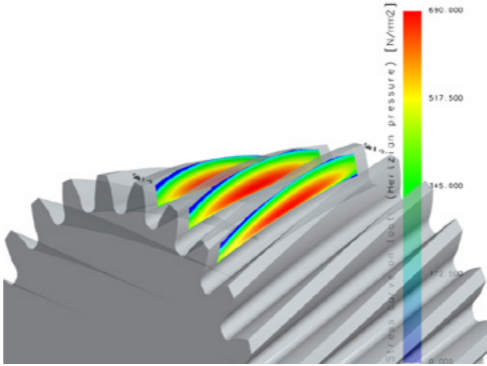

Hertzian pressure distribution on tooth flanks with optimized modifications.

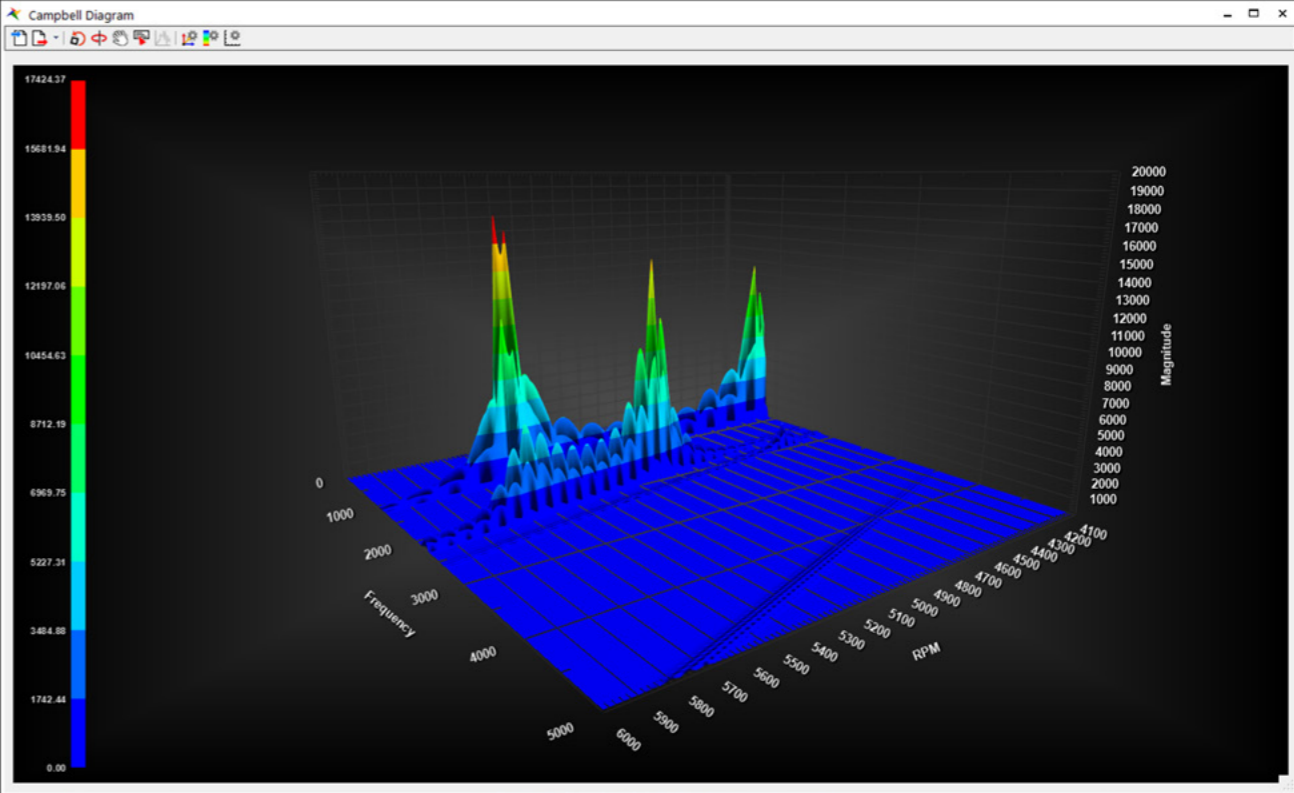

Campbell Diagram 3D for the representation of the natural frequencies as a function of the motor speed.



# Complete Solutions from One Source



**Gleason**

info@gleason.com  
www.gleason.com

